

The G90S is an amateur radio short-wave transceiver with a portable 20W in the SDR architecture. It is a new member of the Xiegu product family and the first portable SDR model in the G series.

Based on 24bit-C0DEC sampling, the G90S brings superior transceiver performance and a highly configurable feature experience; the separate head design allows you to flexibly position your host; with built-in high-performance ATU, you can meet your needs at any time. From then on, the antenna erection and adjustment are no longer problems.

- High-performance RF front end
- SSB/CW/AM/NFM three working modes
- 1.8-inch high-brightness color TFT LCD
- $\pm 24\text{k}$ bandwidth spectrum display, waterfall display
- Software-defined narrow-band filter (CW mode can be as narrow as 50Hz), built-in CW decoder
- Separable head design
- Built-in standing-wave scanner
- Built-in efficient automatic antenna tuner

Please read this manual carefully for a better experience and full understanding on operation of the G90S.

■ G90S is a sales version in the People's Republic of China, and G90 is a sales version in other countries or regions. This operation manual is applicable to the both models. The contents of this manual are explained with the G90S model.

Specification Parameters

General parameters

Frequency range: receiving: 0.5MHz~30MHz

Transmitting: 1.8~2.0MHz	3.5~3.9MHz
7.0~7.2MHz	10.1~10.15MHz
14.0~14.35MHz	18.068~18.168MHz
21.0~21.45MHz	24.89~24.99MHz
28.0~29.7MHz	

Working mode: CW, AM, SSB

Minimum stepping: 10Hz

Antenna impedance: 50 Ω

Working temperature range: 0°C ~ +50°C

Frequency stability: ± 1.5 ppm within 10~60min after startup

@25°C: 1ppm/hour

Supply voltage: 10.5~16.5VDC, negative electrode grounding

Current consumption: receiving: 700mA@Max

Sending: 6A@Max

Dimensions: 120*45*210mm (W*H*L) (not including protrusions)

Weight: about 1.63 kg (host only)

Transmitter parameters

RF output power: 20W (SSB/CW)

5W (AM carrier wave) @13.8VDC

Spurious suppression: ≥ 50 dB

Carrier suppression: ≥ 40 dB

Microphone impedance: 200~10k (600 Ω in general)

Specification Parameters

Receiver parameters

Circuit type: ZIF

Neighbor channel suppression: $\geq 60\text{dB}$

Sideband suppression: $\geq 60\text{dB}$

Sensitivity:

	SSB/CW	AM
0.5-1.799999MHZ	/	10UV
1.8-1.999999MHZ	0.35UV	10UV
2.0-27.999999MHZ	0.25UV	2uV
28.0~30.0MHz	0.25UV	2uV

(PRE=on, ATT=off, NB=off, NR=off, SSB/CW/AM = 10dB S/N)

Mirroring suppression: 70dB

Midband suppression: 60dB

Audio output: 0.5W (8Ω , $\leq 10\%$ THD)

Audio output impedance: 4~16 Ω

- ◆ Above specifications may be changed without notice.
- ◆ Working frequency range of transceiver varies from version of the equipment. Ask local dealer for details.

Accessories of host:

Multifunction hand microphone: 1 pc.

USB data cable: 1 pc.

DB9 extension cable: 1 pc.

Separating head fixing stud: 2 nos.

Small hexagon wrench: 1 no.

Power cable: 1 pc.

Warranty card: 1 pc.

Manual: 1 pc.

Quality certificate: 1 pc.

***Optional components:**

CE19: host ACC adapter (can be used as data communication to transmit audio signal or to connect XPA125B amplifier)

DE-19: external USB adapter

XPA125B: 100W power amplifier + automatic antenna tuner all-in-one machine

Definition of microphone interface

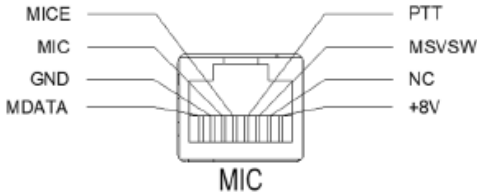

Wiring diagram of COMM plug

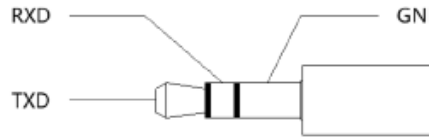

Wiring diagram of earphone plug

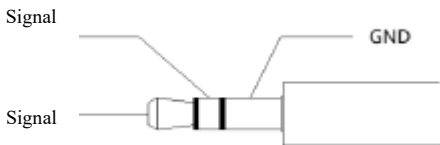

Definition of ACC terminal

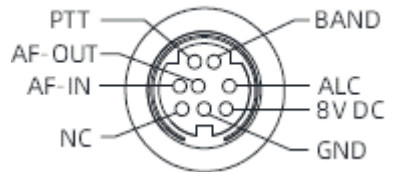

Tail ACC socket

Wire connection of morse key

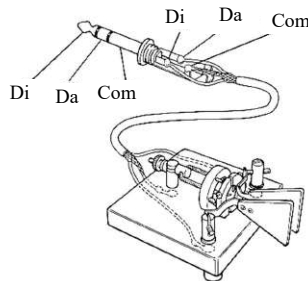

Attention:

- ◆ If the connector of the straight key is a 6.5mm 2-pole plug, please change it to a 3-pole 3.5mm stereo plug according to the wiring method shown in the figure above, and connect the trigger end of the morse key to the "Di" or "Da" terminal.
- ◆ Take care that direct use of the 2-pole to 3-pole adapter or incorrect wiring may result the radio in CW transmitting state all the time.

Machine Interface

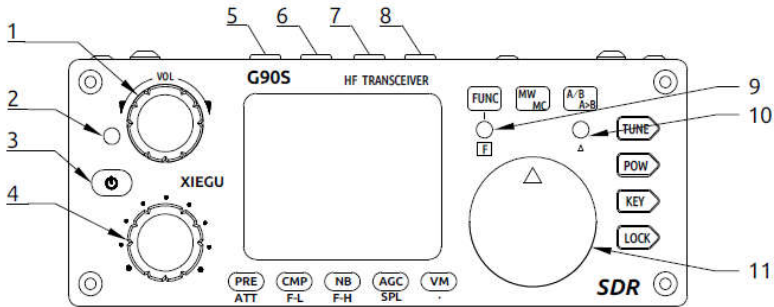

1 Volume knob

- Turn the knob to increase or decrease the volume.
- Short press the knob to switch to the headphone output mode.

2 Power supply/transceiver indicator

- Standby/receiving state: yellow-green;
- It is red under transmitting state.

3 Power switch

- In the power off state, short press this key to turn it on.
 - In the power on state, long press this key to shut it down.
- ◇ Under startup state, short press the key to turn off the screen display and save electricity.

4 Multi-function adjustment knob

- By default, turning this knob will step at 100kHz.
- Long press this knob to switch to the Select Custom function.

5~6 MODE switching: Mode switching. It will switch cyclically among the several modes.

7~8 BAND switching

Band switching. It will switch cyclically from low-frequency stage to high-frequency stage.

9 FUNC indicator

10 This indicator will be on when the second function of the key is operated.

10 ΔF indicator

This indicator flashes along with the signal when it is aligned to the receiving frequency in CW mode.

11 Main knob

Change the current frequency by controlling this knob; or change the menu setting during setting the menu items.

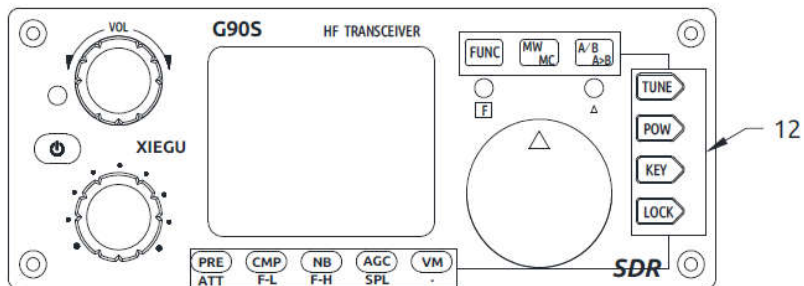

12 Functional key

The key definitions and functions are detailed in the operation section (Page 12).

Machine Interface

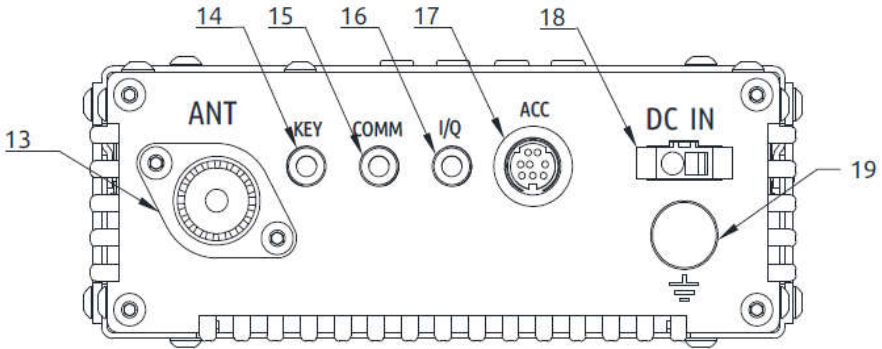

13 Antenna interface

SL16-K type interface, impedance 50Ω.

14 KEY interface

It is a 3.5mm stereo interface used to connect manual/auto telegram keys. (See Page 5 for the wiring method)

15 COMM interface

It is used for updating the machine hardware.

16 I/Q signal output port

It is a 3.5mm interface (3 wires) used for IQ signal output.

17 ACC interface

The interface is an 8-pole mini-type DIN interface. See the interface definition for details. (See Page 5 for the definition of port)

18 DC power interface

External DC power input interface. The round hole is the negative electrode and the square hole is the positive electrode.

19 Ground terminal

Excellent grounding can improve the receiving performance and improve the anti-interference of the radio.

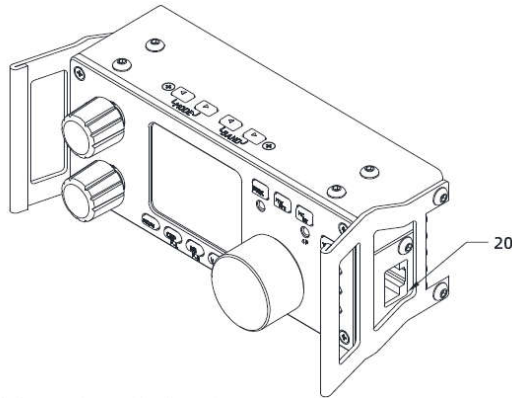

20 MIC (microphone) interface (located on the right side)

It is used to connect attached multi-function hand microphone.

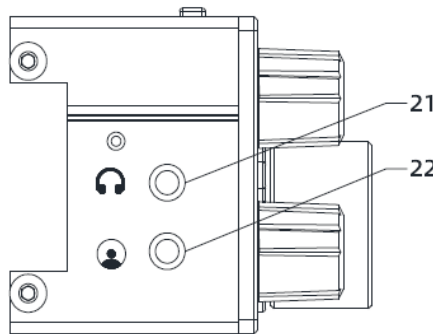

21 Headphone interface (located on the left side)

It is a 3.5mm stereo socket (3 wires) interface used to connect earphones. (See Page 5 for the wiring method)

22 Communication interface (located on the left side)

It is used for hardware updating of head unit and the on-line control with computer.

■ Notes: 1. It is required to insert the USB cable into this port for completing the data communication.

2. Do not insert the cable into this port before startup, otherwise the starting will become abnormal.

Hand Microphone Keys

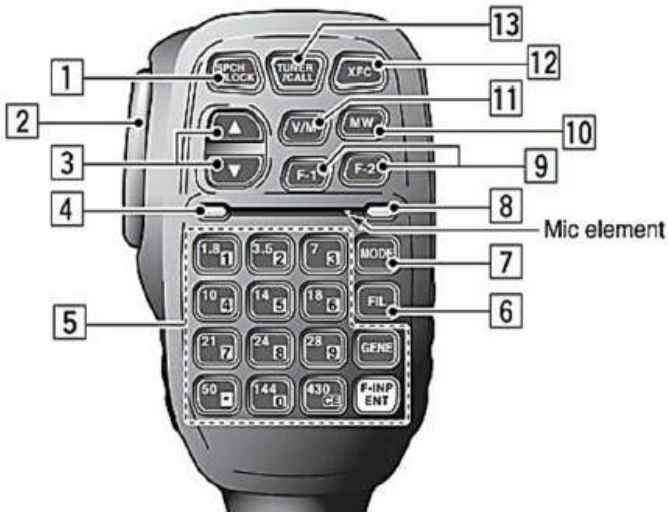

- | | |
|---------------------------|---|
| 1. LOCK key | Lock key |
| 2. PTT key | Transmitting control key |
| 3. Up/down
detailed in | Frequency increase/ decrease key (user-defined,
system menu 1) |
| 4. Transceiver indicator | Hand microphone operation indicator |
| 5. Figure key area | Figure keyboard area |
| 6. FIL key | Filter selection |
| 7. MODE key | Selection of working mode of host |
| 8. Functional indicator | <i>No</i> |
| 9. Function key | F1/F2 key (user-defined, detailed in system menu 2&3) |
| 10. MW key | Memory operation |
| 11. V/M key | Frequency/channel switching |
| 12. XFC key | <i>No function</i> |
| 13. TUNER key | Long-press to enable antenna automatic tuning |

Power supply wiring

The 13.8V external DC power supply is available for G90S. Current load capacity of DC power supply shall be 8A at least. Attached power lines can be used to connect to radio and DC power supply.

DC power supply shall be connected in strict accordance with following figure to avoid reverse polarity connection.

- **Red line shall be connected with the positive pole of power supply and black line shall be connected with negative pole of power supply.**

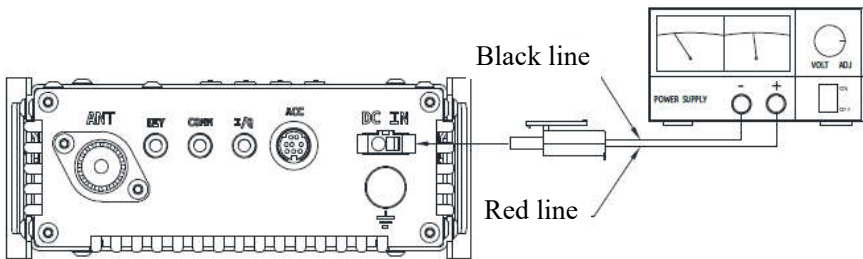

- EMC magnet ring can be applied on power lines to prevent external disturbance from entering radio via power lines and radio-frequency interference in radio from radiating externally via power lines when external power supply is adopted for G90S. Magnet ring shall be installed at the side closing to radio to greatest extent.
- ◆ Polarity of power lines shall be carefully inspected to avoid reverse polarity connection when external power supply is adopted.
- ◆ Reverse connection of power may cause severe damage to the radio.

Functions of Panel Keys and Switching

Keys	First Function (Short Press, Cycle)	Second Function (FUNC+)	Long Press
PRE/ATT	PRE - ATT - direction connection	/	/
CMP/F-L	Turn it on to transmit voice compression	Digital filter F-L, low-pass cutoff frequency selection	Reset parameters
NB/F-H	NB SW - NB Level - NB Width	Digital filter F-H, high-pass startup frequency selection	Reset parameters
AGC/SPL	Open AGC, F-S-A-close and cycle	Turn on the different frequency transceiver operation mode	RF GAIN
VM.	Switch frequency mode or channel mode	/	Call Sign Editor
MW/MC	Turn on channel memory function	Channel clearing	/
A/B.A>B	Switch between VFO-A and VFO-B	Copy the current VFO to the background VFO	/
TUNE	Turn on/off the antenna tuning function	/	Antenna tuning
POW	POWER: transmitting power setting	MIC GAIN: hand microphone gain setting	Standing-wave scanning
	SWR THR: standing-wave protection threshold setting	INPUT: voice input mode selection	
KEY	SPEED: automatic key rate setting	CW Volum: sidetone volume setting	CW Automatic decoding
	M/L/R: manual/automatic left and right mode switching	CW TONE: sidetone frequency settings	
	MODE: iambicA/B mode switching	/	
	OSK: insertion/non-insertion selection	/	
	OSKTime: insertion time setting	/	
	Ratio: setting of automatic key dot-and-dash proportion	/	
LOCK	/	SCALE: spectrum reference level set to AUTO	Lock key
		AVE FFT: mean value setting, ranged 1~10	
Volume knob	Loudspeaker/earphone switching	VOXON/OFF: voice control switch	/
		VOX GAIN: voice control gain setting	/
		ANTI-VOX: hand microphone and speaker echo suppression setting	/
		VOX DLY: voice control transmission turnoff delay	/
Multi-knob	Filter center mode setting	/	/
	Filter bandwidth mode setting	/	/
Main knob	Frequency step selection	Open RIT	/

The operation of the second function:

- Press the [FUNC] key first, then the F indicator will be on, then press the corresponding function key.
- Press the [FUNC] key again to exit the second function. At this time, the F indicator is off.
- In any function (including FUNC second function) setting interface, short press the main knob to save, exit the function setting and return to the main interface.
- Press FUNC in the secondary menu not to save and exit.

Screen Display Icon



Function and definition of display icon:

[P]: pre-amplifier is enabled. The icon character A refers that the pre-attenuator is enabled.

[L]: NB pulse suppressor is enabled

[T]: automatic antenna tuner is enabled

[U]: CMP voice compressor is enabled

[SQL]: muting function is enabled

[UOX]: voice control function is enabled

[AGC-S]: AGC control is at S. (AGC-F, AGC-AUTO, AGC are available)

[13.8V]: external power & voltage display

[USB]: current working mode is USB. (LSB, CW, CW-R and AM modes are available)

[V-A / V-B]: VFO-A is current working frequency (in the figure, SPL is open, and VFO-B is transmitting frequency)

[S]: SPL split frequency receiving & transmitting mode is enabled

[L]: loudspeaker mode. Short press the volume key to switch to the earphone mode, and here displays the earphone icon

[K]: key lock sign.

[S-meter]: in receiving state, S refers to the strength of current receiving signal.

In transmitting state, Po refers to the current transmitting power value



[SWR]: in transmitting state, it displays the standing-wave value of radio antenna port

[Filter]: state indication of receiving filter

Operation

Dear user, in order to familiarize you with the functions and proficiency of the G90S portable transceiver as soon as possible, please read the operation guide of this manual to understand the powerful functions of the G90S. Now get to work!

Transceiver start and shutdown

1. Start the transceiver: short press  key.
2. Shut down the transceiver: press and hold  key for 1s under startup state.

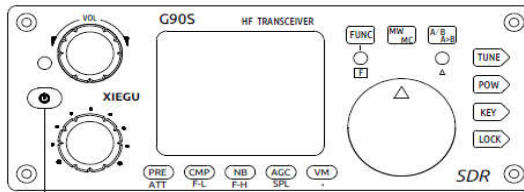

ON/OFF key

Off screen operation:

Under startup state, short press the switch key to turn off the screen display.

- When the screen is turned off, the host is still in normal working condition. Pressing any key or turning the knob will turn up the screen display.
-

Display of power voltage

After turning on the radio, the upper right corner of the screen will display the externally connected DC voltage value.

The external voltage is 13.8V
in the figure



- ◆ Do not supply over-voltage power to the radio, or the radio will be seriously damaged!
- ◆ Due to the line loss and discrete difference of electronic elements, the displayed voltage value may have a deviation of around $\pm 0.3V$ compared with the output voltage of the power terminal.

Selection of working frequency range

Frequency range of G90S covers 0.5~30MHz. Amateur frequency in such range is divided into 10 frequency bands, and frequency band switch can be achieved by adopting many types of different modes.

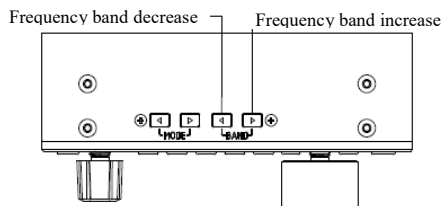

Operation method:

Continuously pressure [$<$] or [$>$] keys of BAND to switch the operating frequency bands cyclically:

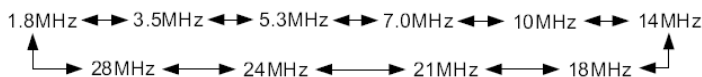

- Each amateur band has a user-defined frequency band that is convenient for temporary use. When the band is switched, the custom band passes. This function can be opened or closed (as detailed in Item 8 of the system menu).
- 60m frequency band shall be opened according to regulations of the country (or region).
- Frequency division for equipment in different versions is different, which shall be in accordance with the regulations of the country (or region).
- VFO-A and VFO-B are two independent VFO modes that can be set to different working conditions. See [VFO Settings] for details.

Working mode selection

Press [MODE] key and switch the fixed sequence below among all modes:

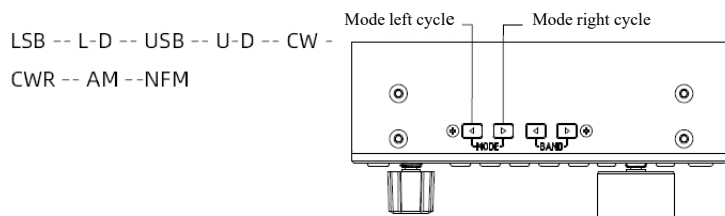

Operation

Volume adjustment

Speaker mode:

Turn the volume knob to the left or right to adjust the output volume.

Headphone mode:

1. Short press the volume knob to enter the headphone mode.
2. Turn the volume knob to the left or right to adjust the headphone volume.

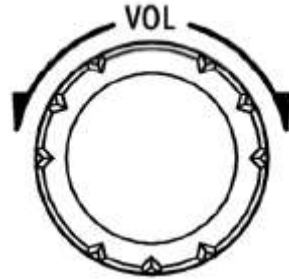

Volume knob

◆ Please turn the volume to the minimum before using earphone for the purpose of protecting your ears. Gradually adjust the volume to be appropriate as required after the earphone is inserted.

Call sign editor

This machine can set the call sign information displayed on the startup interface.

1. Long press the [VM] key to enter the text editor.
2. The bottom of the screen is the character selection area. Rotate the main knob to select the desired character. Short press the main knob to select the character;
3. Press the key corresponding to BACK to delete the last character; press the key corresponding to QUIT to exit the editor interface; press the key corresponding to SAVE to save and exit the editor interface.
4. When the machine is started, the edited text message will be displayed on the screen.

The corresponding relationship between functions and keys:

SAVE: Corresponding to the [PRE] key

BACK: Corresponding to the [NB] key

QUIT: Corresponding to the [VM] adjustment of transmitting power

Working frequency setting

There are two methods for setting working frequency of G90S, i.e., set by using the large knob or multi-function hand microphone.

1. Set frequency by using main knob

- Press the main knob in a short time to select the 100Hz, 1kHz, 10kHz and 100kHz stepping positions;
- Rotate main knob and set the frequency of current step.

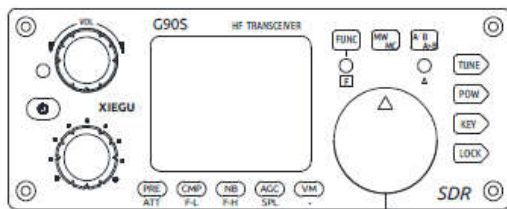

Main knob

2. Set frequency by using multi-function hand microphone

- Press [F-INP ENT] key on hand microphone, and the G90S will be in frequency setting state, and cursor will be flickering at the first place on the left of frequency display position;
- Input expected frequency values one by one, and press [F-INP ENT] key again to complete the frequency setting.

For example, press keys in following sequence to set current frequency as 14.09000MHz:

1. Press [F-INP ENT] key firstly;
2. Press 1, 4, 0, 9, 0 and 0 number keys one by one;
3. Press [F-INP ENT] key again to complete the setting.

Quick adjustment of the frequency

The [Multi-function Adjustment Knob] of G90S provides a method of quickly adjusting the frequency. The knob function can default that the VFO frequency is adjusted at 100kHz position.

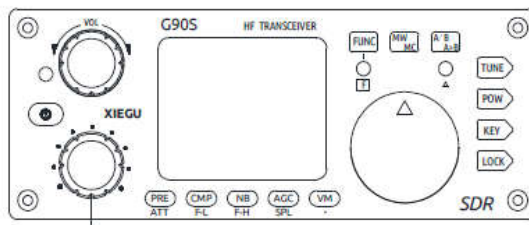

Multi-function adjustment knob

Operation

Adjustment of RF gain and muting level RF GIAN / SQL

Proper RF gain can facilitate to improve the quality of signal received. In general, appropriately reducing the RF gain value at some low-frequency ranges with strong interference can significantly improve the hearing.

Adjustment methods of RF gain:

1. Long press [AGC] key at the bottom of the screen to call the setting option RF GAIN.
2. Rotate the main knob to adjust the RF gain value.
3. After setting, press the main knob in a short time to exit the current setting option.

SQL setting

When muting is necessary for signals or noise less than a certain amplitude, appropriate muting level can be set to disable the audio switch without signal so that the speaker can be muted.

Operation method:

1. Long press [Multi-function Adjustment Knob] to enter the user defined function menu, rotate the main knob to select the SQL Level function, press the SAVE key at the bottom of the screen in a short time to select the function, save and exit.
2. Rotate the [Multi-function Adjustment Knob] to set the muting level. At the same time, the muting grade will display on the screen.

■ The muting grade gradually strengthens from S1 ~S9, corresponding to strength. For example, when the muting grade is set to be S3, it indicates that the speaker will sound when the signal strength is more than S3. Otherwise, the speaker will in the silent mode.

Multi-function adjustment knob

The multi-function knob has several operating options whose functions can be customized.

Default: 100kHz frequency stepping position.

Press in a short time: Enter the receiving filter mode to select.

Long press: Enter the user defined function menu, rotate the main knob to select the corresponding function, and press the SAVE key at the bottom of the screen in a short time to select the function. At this point, the function is set to the [Multi-function Adjustment Knob].

Functions that can be customized are as follows:

- 1) Freq 100k: 100kHz stepping
- 2) SQL Level: Muting setting
- 3)Po Level: Transmitting power setting
- 4) Key Speed: Automatic key rate setting
- 5) FFT Scale: Spectrum reference level AUTO

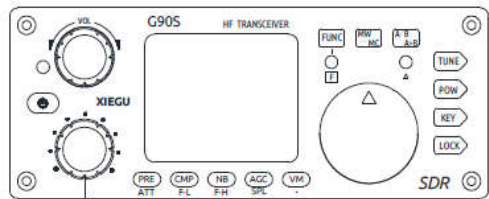

Multi-function adjustment knob

Pilot frequency receiving and sending operation SPL and VFOA/B settings

G90S transceiver has two built-in independent VFOs which can respectively set pilot frequency and modes. Cooperated with SPL function, it can conveniently achieve pilot frequency receiving and sending operations.

VFO setting:

1. Press [A/B/A>B] key in a short time to switch between VFO-A and VFO-B;
2. Set current VFO working frequency and mode when switching to a certain VFO state.

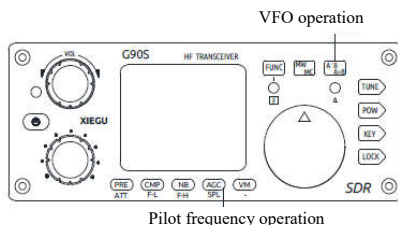

Pilot frequency receiving and sending SPL operation methods:

1. Set receiving frequency and mode (VFO-A) firstly;
2. Set transmitting frequency and mode (VFO-B);
3. Operate the second function of the [AGC/SPL], turn on the SPL function to enable the pilot frequency transceiver mode and the double-triangular icon will also display on the VFO area of the screen.

◆ VFOA/B can be fully used to set pilot frequency and modes so as to quickly switch the two frequency points in real time.

Automatic Gain Control (AGC)

Select appropriate AGC control parameters in different working modes to achieve a good receiving effect.

1. Press [AGC] key at the bottom of the screen in a short time, enable/ disable or select different AGC modes and circulate them in the following order:

AGC-S→AGC-F→AGC-A→AGC--

AGC-S: slow AGC control

AGC-F: fast AGC control

AGC-A: automatic AGC control

AGC--: AGC off

Recommended settings:

AM mode: AGC-S; SSB/CW mode: AGC-F

2. When the AGC-A mode is selected, the radio will automatically select the appropriate AGC control parameter according to the current working mode.

■ After AGC is disabled, the receiver will be in the maximum gain state and noise received will be significantly increased.

Operation

Pre-amplifier/pre-attenuator PRE/AT

The pre-amplifier can improve the receiving effect of some weak signals of high frequency range and the sensitivity of the receiver.

1. Press [PRE] key at the bottom of the screen in a short time and the character P will appear on the top left corner of the screen, indicating that the pre-amplifier is turned on.
2. Press [PRE] key again in a short time and the character A will appear on the top left corner of the screen, indicating that the pre-attenuator is turned on.
3. Press [PRE] key again in a short time and no character will appear on the top left corner of the screen, indicating that the current state is shoot-through state.

■ Before they are used in frequency range less than 14MHz, disabling the pre-amplifier is recommended so that the radio can be in the shoot-through state, which is conducive to strengthen the front-end performance of the receiver and reduce the influence of interference signals.

■ When the S meter displays that the received signals exceed S9+20dB, turning on the pre-attenuator is recommended to avoid the decreasing of the state of the receiver due to strong signals.

Pulse interface suppressor NB

Pulse interference suppressor can effectively eliminate some kinds of pulse noise, especially the interference caused by automobile ignition system.

1. Press [NB] key at the bottom of the screen in a short time to enter the NB function setting, and corresponding menu will display on the screen.
2. Continue to press [NB] key in a short time to select different NB function setting menus, and rotate the main knob for setting.

The NB function menu includes the following options:

- NBSW: NB function switch. Default OFF
 - NB Level: setting of NB suppression level.
 - NB Width: setting of NB suppression width
 - NB suppression width and level can be properly adjusted to effectively suppress different kinds of pulse interference.
 - improper NB parameter setting will severely affect the receiving effect.
- Disabling the NB function at ordinary times is recommended.
-

Voice compression CMP

The voice compression can increase the average power output during the voice communication so that signals can be resonant.

1. Press [CMP] key at the bottom of the screen in a short time and the mark of voice compression will appear on the screen, indicating that the function is enabled.
2. Press [CMP] key at the bottom of the screen again in a short time to disable the voice compression.

CW communication

Use manual tapper or external keying unit to insert into the KEY port at the tail of the radio (See Page 5 for the definition of wiring)

1. Insert keys into the KEY port;
2. Press [MODE] key to switch to CW (or CWR) mode;
3. Open the QSK function in the [KEY] key function and set the appropriate QSK time;
4. Press the morse key to enable CW communication.

Practice mode

You can take G90S as a CW code trainer in following methods:

- Disable the QSK function in the [KEY] key function. There will be only CW sidetone of transceiver after pressing the morse key under such conditions, but signals will not be transmitted externally.

CW automatic decoding

Long press [KEY] key to enable the CW automatic decoding. Rotate the main knob to do the fine tuning of the received frequency till the Δ indicator flashes with the code. At this time, the information about the telegraph text after decoding will appear at the bottom of the screen.

■ Since the accuracy of CW automatic decoding is related to the reporting accuracy, signal propagation quality, and frequency accuracy of the other radio, the CW automatic decoding can be used as an auxiliary decoding means cooperating with the human decoding. When the automatic decoding is used, the bandwidth of the receiving filter is recommended to be 300Hz.

The [KEY] key function includes common function setting items during CW communication. Press the key in a short time to select:

- SPEED: automatic key rate setting
- M/L/R: settings of manual/automatic left-and right-hand modes
- MODE: lmbic A/B mode setting
- QSK switch: switch setting
- QSK Time: QSK time setting
- Ratio: setting of automatic key dot-and-dash proportion

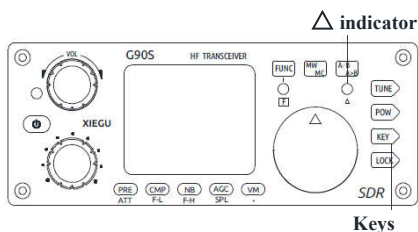

Enter the second function of [KEY] key to set CW sidetone volume and tone, and press [KEY] key in a short time to switch the options:

- CW Volum: sidetone volume setting
- T800Hz: sidetone tone setting
- B500: CW receiving band setting (the default value is 500Hz)

Operation

SSB communication

Insert the hand microphone into the MIC port on the right side of the radio head unit. After inserting, the green indicator on the hand microphone shall be on.

1. Press [MODE] key (< or >) at the top of the head, and switch to LSB or USB mode.
2. Enter the second function of [POW] key for the following settings:
 - 1) MIC GAIN: setting of hand microphone voice gain (default value recommended)
 - 2) INPUT: setting of input mode (the default is MIC and select MIC during voice communication)
 - 3) B2400: SSB mode defaults to be bandwidth setting, indicating that the band width is 2.4kHz.
3. Enter the first function of [POW] key and press the key in a short time to set the transmitting power value:
 - 1) POWER: transmitting power setting (the default is 1W)
 - 2) SWRTHR: setting of standing-wave protection threshold (the default is 3.0)
4. After the above settings are completed, the single-band voice communication is started.

■ The defaulted hand microphone voice gain value can meet the demand of voice communication in most cases. In case of superfluous spectral lines with relatively low magnitude on both sides of voice spectral lines displayed on the screen, the hand microphone voice gain value can be appropriately adjusted till superfluous spectral lines disappear.

Voice-control transmission VOX

The voice-control transmission VOX can automatically judge whether there is hand microphone voice signal or line input signal, so as to automatically control the radio to switch between the receiving and transmission. After the VOX function is activated, it is unnecessary to press the hand microphone PTT key to start the transmission.

After pressing [FUNC] key to activate the second function, press the volume knob in a short time to enter the VOX function setting option and circularly press the volume knob in a short time to switch menus.

- VOX OFF/ON: VOX function off/ on
- VOX GAIN: voice control gain setting (the recommended setting: 50)
- ANTI-VOX: echo suppression settings of hand microphone and speaker (the recommended setting: 50)
- VOX DLY: voice control triggering turnoff delay setting (the default: 0)
- The voice control function can be utilized for both the hand microphone and the line input LINE.
- When the AF IN port of the ACC interface is used for line input voice control, set the appropriate input volume in the "AUX IN Volum" option in the system menu.

Automatic antenna tuner

There is an efficient ATU integrated inside the G90S radio to help you quickly erect and debug antenna.

1. Short press [TUNE] key to connect with built-in antenna tuner. There will be an antenna icon at the top of screen.
2. In the case that the antenna tuner is accessed, long press the [TUNE] key for 1s to start ATU automatic tuning functions. It will automatically return to receiving state after the tuning.

Attention:

1. Short press [TUNE] key, and there will be an antenna icon at the top of screen, indicating that antenna tuning functions are enabled. The functions are only enabled but not working.
2. After the antenna tuner is tuned, the antenna tuner must remain to be open before the antenna tuner in the machine is used.
3. If "SWR" icon is displayed at the top of the screen and flashes once transmitting is enabled after the tuning, it indicates that standing-wave of current antenna is still large and tuning is required to be carried out again.
4. Antenna tuning shall be turned off once natural resonance of antenna reaches current frequency band.
5. When a whip antenna is used and the internal antenna tuning is started for tuning, strong radio frequency interference may be caused to the unit or electronic equipment.

Standing-wave scanner SWR

The G90S host has the antenna standing-wave scanning function, which can scan the standing-wave parameters of the current antenna to help users adjust the antenna.

1. Long press the [POW] key to enable the standing-wave scanning function. Scan the standing wave of the antenna in the current frequency band.
2. Short press the key corresponding to BW displayed on the screen to switch the frequency stepping of scanning.
3. In the middle of the bottom of the screen, the frequency of the lowest point of the scanned standing wave is displayed.
4. Short press the key corresponding to FAST/SLOW displayed on the screen to select the scanning speed.
5. Short press the key corresponding to the QUIT displayed on the screen to exit the standing-wave scanner.

Corresponding relationship between keys:

BW: Corresponding to the [PRE] key

FAST: Corresponding to the [NB] key

QUIT: Corresponding to the [VN] key

◆ The scanning results from the standing-wave scanner may have some errors, for reference only of temporary use. For accurate measurement of antenna standing waves and other data, please use the professional antenna analysis equipment for measurement.

Operation

Fine tuning of received frequency (RIT)

Operation method:

1. Long press the main knob to enter the RIT adjustment interface.

Spectrum display area

-108dBm

R +55

2. Rotate the main knob left or right to adjust the RIT value. The adjustment range is $\pm 500\text{Hz}$ and relevant information is displayed in the upper right corner of the spectrum display area.

◆ After RIT function is used, reset the RIT value to be 0 to avoid affecting the normal use.

Channel memory MW and Clear MC

Basic operations:

1. In VFO mode, adjust the required frequency, mode, advanced function status and other parameters.
2. Press [MW/MC] key in a short time and the CH 00 (channel number) character will appear on the screen and flash. Rotate the main knob to select an empty channel. At this time, the character E will appear after the channel number, indicating that the channel is empty and can be used for memory.
3. Press [MW/MC] key again in a short time to save the current set frequency information to the selected channel.

Call the memory channel:

1. In VFO mode, short press the [VM] key on the panel to enter channel mode;
2. Rotate the main knob to switch the current channel.

Clear the channel memory:

1. In channel mode, press the combination keys [FUNC] + [MW/MC], at which point the channel number starts to flash;
2. Rotate the main knob to the channel to be cleared. Press [MW/MC] key again to clear the selected channel.

Transmitting power setting

1. Press [POW] key in a short time to enter power settings state, and the function display area on the right side of the screen will display the Po power setting value.
2. Rotate the [Multi-Function Adjustment Knob] to set the power, with the stepping of 1W.

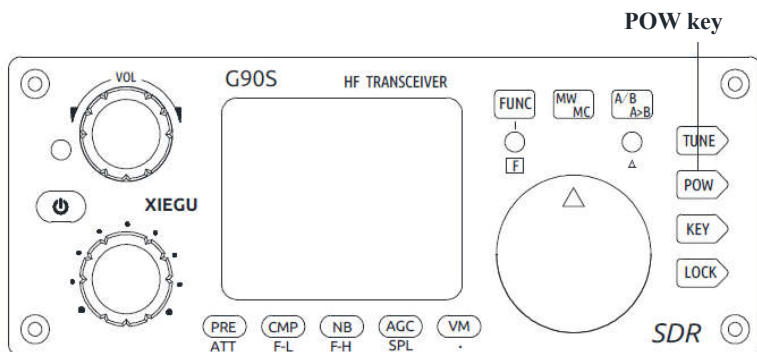

- ◆ Please minimize the preset transmitting power when the G90S radio is used for the first time under the condition of not understanding the current state of antenna.

Operation

Digital filter

The G90S has a built-in variable digital filter that can continuously adjust the bandwidth of the filter and improve the anti-interference performance and selectivity of the radio.

Operation method:

1. The band-pass filter is changed to a combination of two BPFs, and the default value for each working mode is:

Mode	BPF 1	BPF 2	Belt width
SSB	300~3000	300~3000	2700
SSB DIG	100~3100	100~3100	3000
CW	-250~250	-250~250	500
AM	-3000~3000	-3000~3000	6000
NFM	-4500~4500	-4500~4500	9000

*Note: A negative frequency indicates that the frequency is located on the left side of the spectrum center (i.e., the lower sideband).

2. Operation method of adjusting band-pass filter:

Short press the [MFK] multifunction knob to select the band-pass filter (taking the SSB default filter bandwidth as an example):

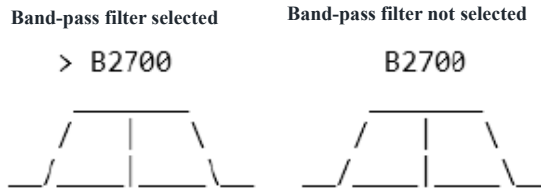

When the band-pass filter is selected:

- ▷ Short press the MFK key to switch between BPF1 and BPF2;
- ▷ Turn the MFK encoder to adjust the selected BPF;
- ▷ Long press the MFK key to exit the selection;
- ▷ Press the FUNC key to exit the selection;
- ▷ Press other menu keys (such as POW, KEY, etc.) to exit the selection;

When the FUNC light is on:

- ▷ Short press the [CMP/F-L] key to set BPF1 to the default value;
- ▷ Short press the [NB/F-H] key to set BPF2 to the default value;

■ Reminder:

- ▷ The B2700 above the filter icon indicates BandWidth=2700Hz, namely, bandwidth=2700Hz.

The parameters of the filter bandwidth are shown in the following figure:

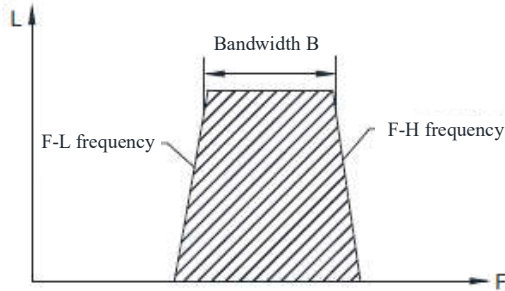

Filter Bandwidth Schematic Diagram

- ◆ Properly adjusting the filter parameters can greatly improve the performance of the receiver as well as its sensitivity and signal to noise ratio.
- ◆ In CW mode, the digital filter can be minimized to 50Hz, but there will be obvious kettle effect. Attention shall be paid to the selection of appropriate bandwidth to gain the best hearing.

Operation

Spectrum/waterfall display

The G90S radio can display the spectrum diagram and waterfall diagram of receiving signals and can quickly observe whether there is communication signal on the neighboring frequency so that users can quickly track and switch frequencies and search the radio.

- Spectrum display bandwidth: 48kHz
- The spectrum signal strength value displays the accuracy: $\pm 2\text{dB}$
- SCALE is set to AUTO mode by default, which is to automatically adjust the current reference level.

The second function meter of the [LOCK] key is as follows:

- SCALE: reference level automatically set to AUTO
- AVE: average value setting

AVE average values shall be set gradually increasing from 1 to 10. The display effect of the spectrum will be increasingly smooth with the setting increasing of the average value.

The average value can be set according to personal habit.

Data communication

The G90S supports all amateur data communication modes and the full-function control of the computer software to the radio. Only simple wiring is needed for the amateur data communication.

Appropriate digital work mode shall be selected before operation. The recommended common working modes are as follows:

Data Mode	Radio Setting Mode
PSK31	U-D
RTTY	L-D
FT8	U-D

*** The radio working mode required for other data modes can be set in accordance with the using habit of amateur radio communication.**

➤ Data mode: U-D, L-D, indicating USB DIG and LSB DIG. After the data mode is selected, the LINE IN of the ACC port is selected and automatically connected to the line (at this time, the hand microphone will be muted), and the LINE OUT is turned on.

When amateur radios and the computer cooperate with on data communication, the computer is used as a "modem". While receiving, the signal received by the radio is transmitted to the computer for demodulation; while transmitting, the signal modulated by the computer is transmitted to the radio for transmission. The signal transmission direction and relationship are as follows:

While receiving: the radio receives the signal → computer

While transmitting: the computer generates the signal → radio

Preparations:

- The radio USB data cable (USB-3.5mm plug), and the driver of the data cable which has been correctly installed on the computer (the port number is visible in the equipment manager. The yellow exclamation point indicates that the equipment installation is abnormal).
- Several EMC magnetic rings (self-provided)

Wiring method 1: (using CE-19)

1. Insert the 3.5mm plug of the universal data cable into the communication port on the left side of the G90 head, and insert the USB into the computer.
2. Insert the delivered 8-pole ACC cable into the ACC port at the end of the G90 and the other end into the corresponding port on the CE-19 (note that there is only one 8-pole port).
3. Insert one end of the delivered audio cable into the AF CON interface of the CE-19, and, according to the wiring diagram on the CE-19 panel and connecting method of the audio input/output port of your own computer, connect the other end with a 3.5mm stereo plug, and insert it to the audio port on the computer.

Wiring method 2: (using DE-19)

Connect G90S to the computer with DE-19*M adapter and see the following picture for connection. Other settings are the same as above.

- The external input signal strength shall be within the ALC control range to avoid the input overloading.

Operation

- The EMC magnetic ring on the USB data cable and the audio cable close to the computer end card can eliminate the interference of the RF signal to the USB port of the computer, stabilizing the connection.
- Refer to relevant software instructions for the operation method of the PC software.

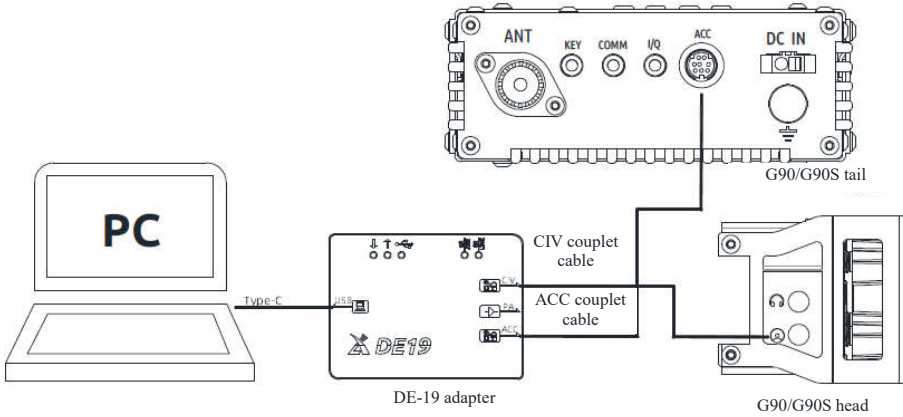
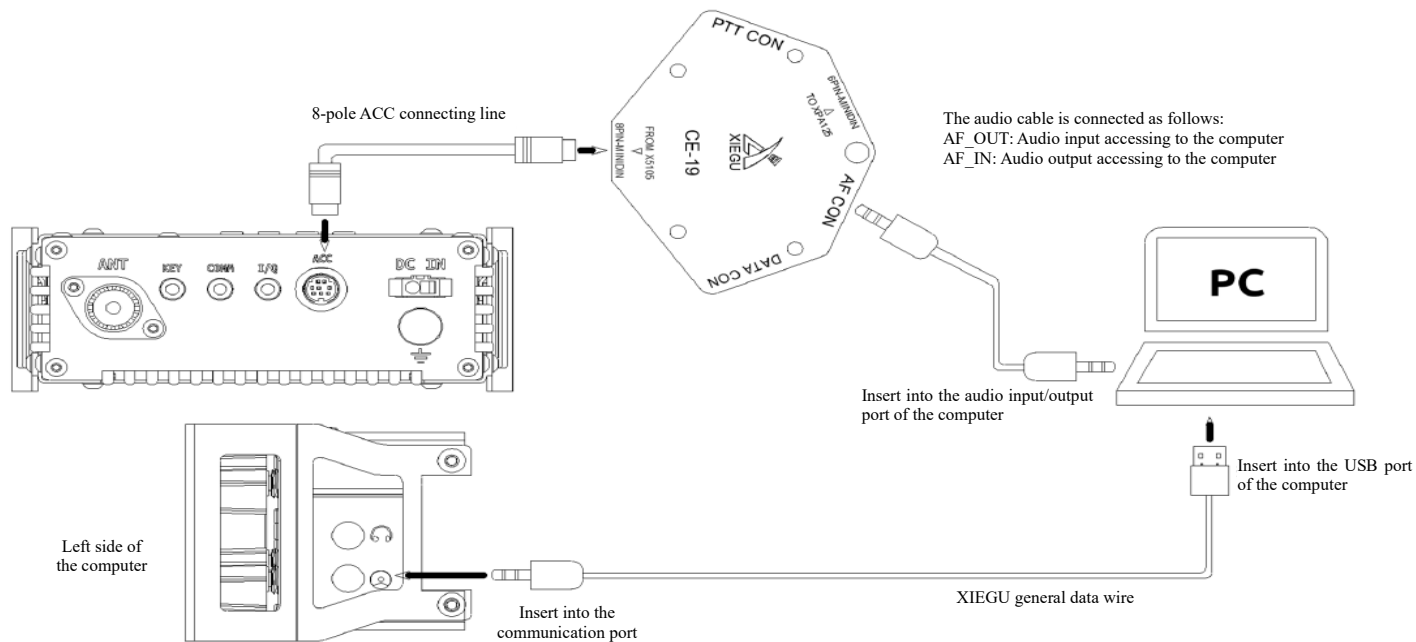

Figure Schematic Diagram of Connection between DE-19 and G90S

*The DE-19 is an optional external USB adapter which can facilitate the connection and transmission with a computer.

The audio head wiring diagram is on CE-19 panel
 The joint definition in this diagram indicates the output signal terminal of the radio.



Schematic Diagram of Connection between CE-19 and G90S

Operation

Connection between G90S and XPA125B (optional)

After the G90S connects with XPA125 power amplifier and antenna tuner AIO through the CE19 adapter, the output power can be expanded to 100W.

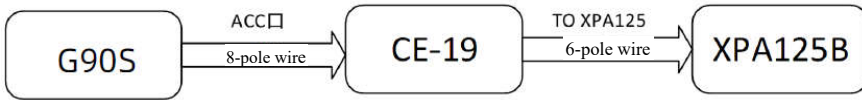

Schematic Diagram of Wiring between G90S and XPA125B

After connection, the G90S can automatically control the wave band switching of XPA125B. Moreover, the ALC control will be built between two machines. When the G90S output power exceeds the power limit of the XPA125B, the AACL control will automatically decrease the output power of the radio so that the output power of the XPA125B will be kept to be about 100W.

We suggest that the output power of the G90S is set to be $\leq 2.5W$ to protect the amplifier equipment.

- The 8-pole ACC wire is delivered in the CE19 kit, and the 6-pole ACC wire is delivered in the XPA125B packing case.

Description of System Menu

System menu

The system menu enables customized setup for partial functions. You may use this feature to configure the settings suitable for you.

Operation method: Hold the [FUNC] key to enter the system menu.

The definitions of menu functions are as follows:

SER.	Menu Name	Function Description
1	Handle up/down	Hand microphone up/down key function setting
2	Handle F1	Hand microphone F1 key function setting
3	Handle F2	Hand microphone F2 key function setting
4	LCD BL	Screen backlight brightness setting
5	AUX IN Volum	ACC port input audio volume setting
6	AUX OUT Volum	ACC port output audio volume setting
7	RCLK Tune	Reference clock adjustment
8	Band Stack Mode	Band stack setup
9	ON/OFF Beep	ON/OFF of system prompt tone
10	Version	Firmware version No.

Description of the multi-function key displayed at the bottom of the screen:

PREV: Previous page.

SAVE: After adjusting the system menu settings, press this key to save and exit.

EXIT: Exit the system menu interface directly.

NEXT: Next page.

Menu item 1: Handle up/down

Function: Customize the function of [▲▼] key on multi-purpose hand microphone.

Optional value: FREQ CH+/- Frequency/channel+/-
 BAND+/- Band +/-
 VOLUM+/- Volume +/-

defaults: FREQ CH+/-

Menu item 2: Handle F1

Function: Customize the function of [F1] key on multi-purpose hand microphone.

Optional value: PRE/ATT
 SPLT
 NB
 COMP
 AGC

Default: PRE/ATT

Menu item 3: Handle F2

Function: Customize the function of [F2] key on multi-purpose hand microphone.

Optional value: PRE/ATT
 SPLT
 NB
 COMP
 AGC

Default: SPLT

Menu item 4: LCD BL

Function: Set the brightness of display backlight

Optional range: 10%~100% The larger the percentage, the higher
the brightness

Default: 80%

Menu item 5: AUX IN Volum

Function: Set the volume of ACC port input audio signal

Optional range: 0~15 The large the value, the greater the
volume

Default: 8

Menu item 6: AUX OUT Volum

Function: Set the volume of ACC port output audio signal

Optional range: 0~15 The large the value, the greater the volume

Default: 15

Menu item 7: RCLK Tune

Function: Regulate the reference clock of radio's internal frequency combiner. Able to correct the frequency deviation of the radio.

Optional range: -1000Hz~+1000Hz

Default: 0Hz

E.g.: when you think that signal tone you hear is 20Hz below the correct frequency, set this item at 20Hz;

When you think that signal tone you hear is 20Hz above the correct frequency, set this item at -20Hz;

Menu item 8: Band Stack Mode

Function: Set band stack. During the switch of frequency band, enable/cancel the display of non-amateur frequency bands in the band stack.

Optional value: HAM Band	Only display amateur frequency bands
FULL Band	Display all frequency bands

Default: HAM Band

Menu item 9: ON/OFF Beep

Function: Enable/disable and the system prompt tone. Enable/disable the prompt tone at startup & shutdown.

Optional value: Enable / Disable

Default: Enable

Menu item 10: Version

Function: Display the firmware version No. of head and body.

APP: VI.XX Head firmware version No.

BASE: VI.XX Body firmware version No.

Factory Default Reset

Factory default reset

When the parameters of the radio are disarranged or in case of any other situation that causes improper parameters, this function enables the restoration of factory settings.

* Firmware version 1.73 or above supports reset.

Operation method:

1. In the shutdown state, press and hold the FUNC key (do not release), and then short press the power switch. Do not release the FUNC key until a text message appears on the screen.
 2. Press the PRE key to confirm the reset operation. Press the VM key to cancel the reset operation and exit.
- Default parameters can meet most operating needs, ensuring the radio is working under good conditions.

CIV control instructions

Computer control instructions

G90S adopts standard CIV instruction sets. You can remotely control the transceiver based on standard instructions of the instruction set or configure control instructions of other software, so as to achieve the control on G90S.

See specific specifications of CI-V commands in *CI-V COMMUNICATIONS INTERFACE-V REFERENCE MANUAL*.

Wave band voltage data

The ACC socket of the BAND terminal of G90S outputs the band voltage of each frequency band. This band voltage is associated with the current frequency band of the radio and can control peripherals to achieve automatic wave band switch or can be used by other equipment to identify wave brand information.

Wave Band	Voltage	Wave Band	Voltage	Wave Band	Voltage	Wave Band	Voltage
1.8MHz	230mV	7MHz	920mV	18MHz	1610mV	28MHz	2300mV
3.5MHz	460mV	10MHz	1150mV	21MHz	1840mV	/	/
5.0MHz	690mV	14MHz	1380mV	24MHz	2070mV	/	/

Copyright Statement

Copyright © 2022

All rights are reserved by Dongguan Weisheng Communication Technology Co., Ltd. Reproduction of any part of this Manual without permission is prohibited.

1010160204-C

The fourth revision was made on October 10, 2022.